

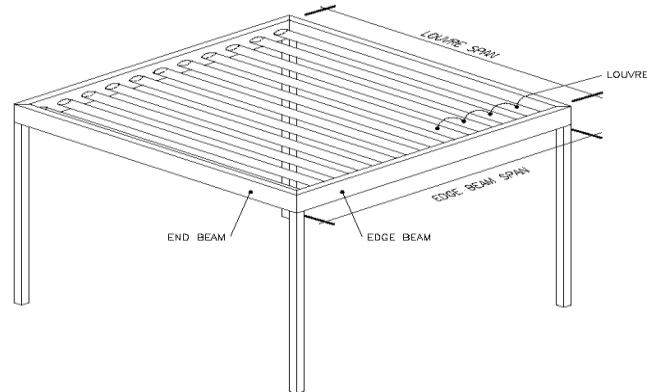

Unit 8, 357 Madras Street
 Christchurch, New Zealand
 P.O. Box 13-282
 Armagh, Christchurch 8141
 New Zealand
 Telephone (03) 366-4320
 Fax (03) 365-7069
 Email eng@lewisandbarrow.co.nz
 www.lewisandbarrow.co.nz

250 Deep Louvre Solutions Edge Beam Safe Span In Metres



Louvre Solutions Edge Beam Safe Spans In metres

16907/A LOUVRE SPAN in metres	WIND LOADS				SNOW LOADS	
	Light up to 32m/sec	Medium up to 37m/sec	High up to 44m/sec	Very High up to 50m/sec	0.63kPa	1.0kPa
2.5	7.3 (8.0)	6.6 (8.0)	5.4 (7.3)	4.7 (6.7)	7.4 (8.0)	6.6 (8.0)
2.75	7.1 (8.0)	6.3 (8.0)	5.2 (7.1)	4.5 (6.4)	7.2 (8.0)	6.3 (8.0)
3.0	6.9 (8.0)	6.0 (7.8)	4.9 (6.9)	4.3 (6.1)	7.0 (8.0)	6.0 (7.8)
3.25	6.7 (8.0)	5.7 (7.6)	4.7 (6.7)	4.1 (5.9)	6.8 (8.0)	5.7 (7.6)
3.50	6.5 (8.0)	5.5 (7.4)	4.6 (6.5)	-	6.7 (8.0)	5.6 (7.4)
3.75	6.3 (8.0)	5.3 (7.2)	4.4 (6.3)	-	6.5 (8.0)	5.4 (7.2)
4.0	6.1 (7.9)	5.2 (7.0)	-	-	6.3 (8.0)	5.2 (7.1)

Figures in brackets are for two beams screwed together to act as one beam

1. Edge beam to be 250 x 50 x 3mm section. Alloy 6060-T5.
2. Use horizontally as a canopy, awning, or sunshade.
3. Can be used for a stand alone carport or against a larger building.
4. The allowable spans for the 16907/A louvre blades are shown below.

Low wind speed (up to 32m/sec)	Allowable Span = 4.8 however practical limit is 4.0m
Medium wind speed (up to 37m/sec)	Allowable Span = 4.3 however practical limit is 4.0m
High Wind Speed (up to 44m/sec)	Allowable Span = 3.8m
Very High Wind Speed (up to 50m/sec)	Allowable Span = 3.4m
Up to 0.63kPa Snow Load	Allowable Span = 4.6 however practical limit is 4.0m
Up to 1.0kPa Snow Load	Allowable Span = 4.0m

5. Low, medium, high and very high wind speeds are determined for small buildings using N.Z.S. 3604:2011. The 32m/sec, 37m/sec, 44m/sec and 50m/sec wind speeds are site wind speeds as defined by N.Z.S. 1170:2002.