

24V CONTROL UNIT WITH RADIO RECEIVER TO CONTROL ONE 24V MOTOR FOR ADJUSTABLE SLATS

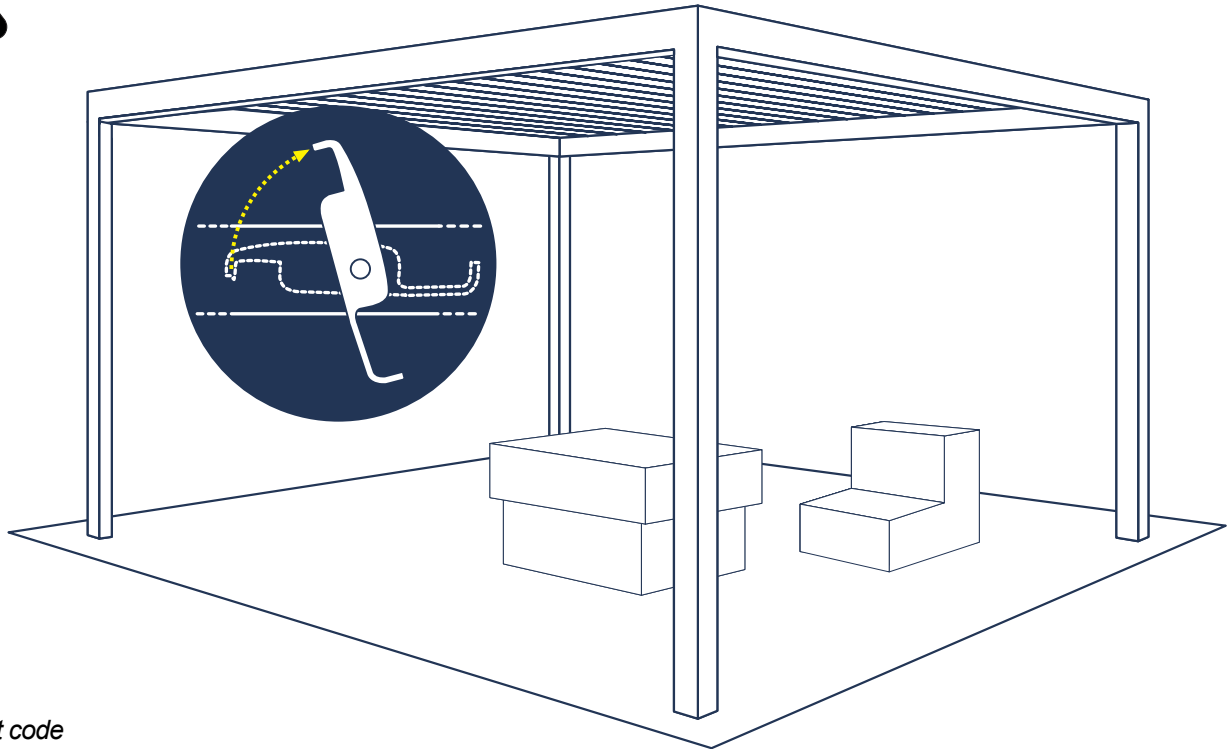

Product code

TVPLS916CTS1

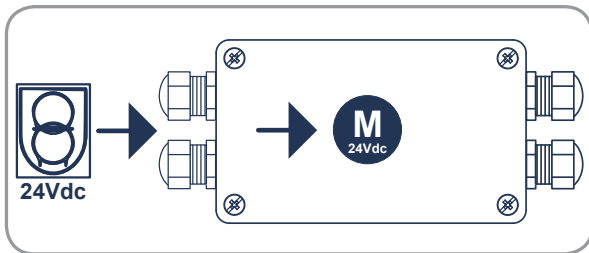

Inputs for rain and wind sensors

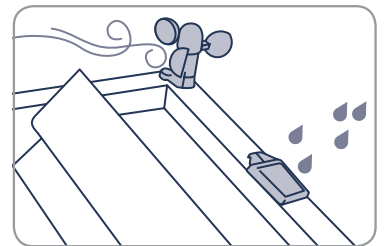

Limit-switch and working time self-learning

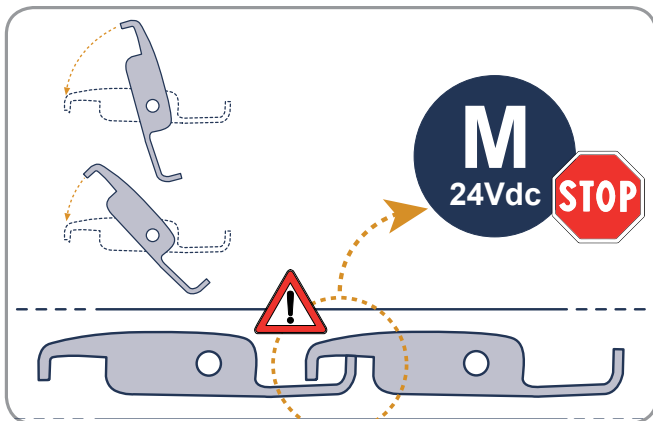

Manual push-button inputs
(hold-to-run mode)

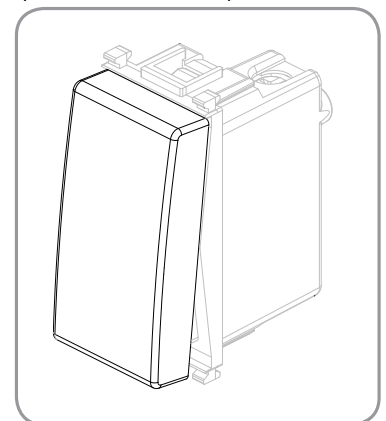
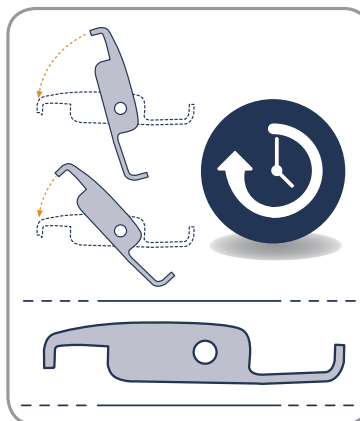



INDEX



WARNINGS

- 1. Connections and adjustments** p. 2
- 2. TRANSMITTERS** p. 3 - 5
 - 2.1 Radio codes memorization
 - 2.2 Working time configuration
 - 2.3 Radio codes deletion
 - 2.4 Remote memorization of other radio codes
 - 2.5 Remote deletion of a radio code
- 3. SENSORS** p. 6
 - 3.1 WIND sensor
 - 3.2 RAIN sensor
- 4. Technical specifications** p. 7

The product at issue must be installed, commissioned and maintained only by licensed and authorised people, respecting the laws concerning the automatic covers. The system is powered by 24Vdc. Before the connection to the power supply make sure that the sensors and motors are correctly connected. A faulty connection of the motors (polarity inversion) could damage them together with the connected mechanical elements. The power supply must supply the required voltage and current according to the characteristics of the system. The power supply must be compliant with IEC60950-1 and must be protected against the short-circuit and over-voltage. Use a 2x1.5mm cable to connect the motors and the control unit for length up to 6m, or 2x2.5mm cable for longer segments.

PRODUCT DISPOSAL: at the end of this product's useful life, it must not be disposed of as domestic waste, but must be taken to a collection centre for waste electrical and electronic equipment.

Hereby Teleco automation s.r.l. declares that the product complies with the essential requirements and other relevant provisions, established by the Directive 1999/5/EC. The declaration of conformity can be consulted on the web site: www.telecoautomation.com/ce. In the view of a constant development of their products, the manufacturer reserves the right for changing technical data and features without prior notice.

1 Connections and adjustments

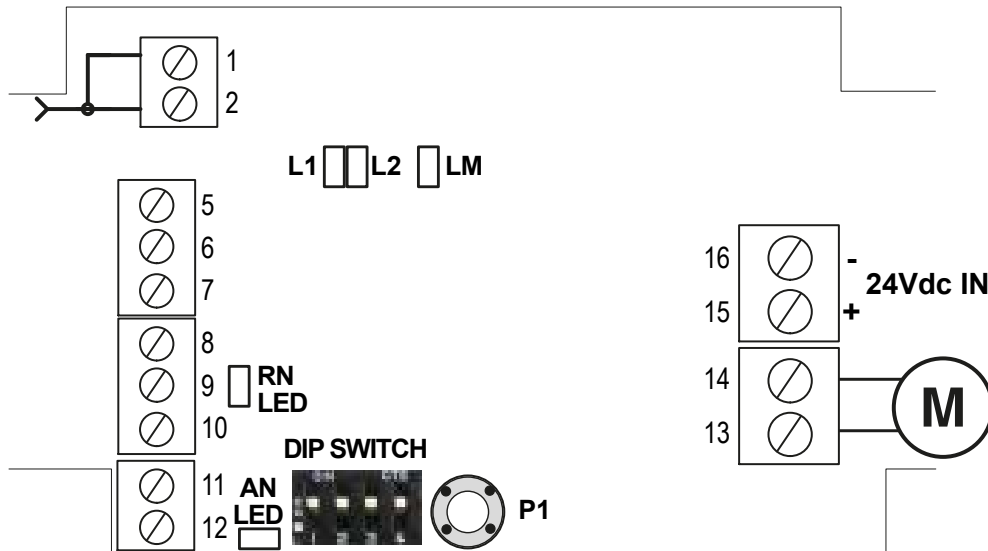

MOTOR STOPS. The control unit stops the motors at the point of a mechanical stop through current absorption. The threshold can be set with **DIP1** and **DIP2** (table). **Attention!** Check that the motor only stops at the mechanical stops (**LM = ON**): increase the threshold if the motor stops during operation or decrease if the motor continues to push against the mechanical stops.

DIP1	DIP2	(A)
OFF	OFF	1
OFF	ON	2
ON	OFF	3
ON	ON	4

Default

1	AERIAL GND
2	AERIAL RF
5	INPUTS COMMON
6	HOLD-TO-RUN CLOSE INPUT (N.O.)
7	HOLD-TO-RUN OPEN INPUT (N.O.)
8	RAIN SENSOR (YELLOW, GND)
9	RAIN SENSOR (BLUE, SIGNAL)
10	RAIN SENSOR (WHITE, +12V)
11	WIND SENSOR (BLUE)
12	WIND SENSOR (BROWN)
13	MOTOR (CLOSE)
14	MOTOR (OPEN)
15	+24Vdc POWER SUPPLY
16	POWER SUPPLY GND
AN LED	WIND SENSOR PULSES
RN LED	RAIN SENSOR ACTIVE
L1	ON = RAIN ALARM
L2	FLASHING = WIND ALARM
LM	LIMIT SWITCH LED
P1	PROGRAMMING BUTTON

A
ONE SINGLE BUTTON FROM ANY TRANSMITTER TYPE

B
AUTOMATIC COMMANDS
(2 or 3 BUTTONS)

C
TRANSMITTER RESERVED FOR PERGOLA CONTROL

7/42 channel transmitter

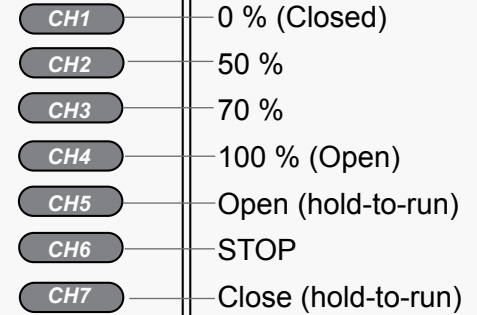
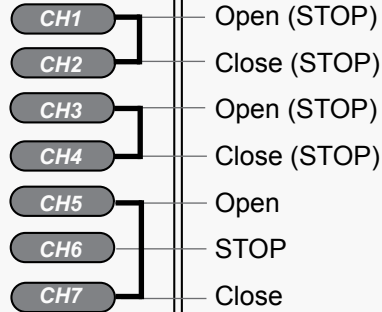
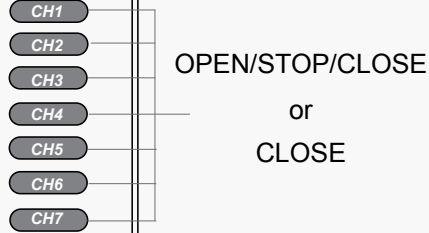



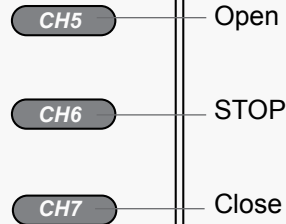



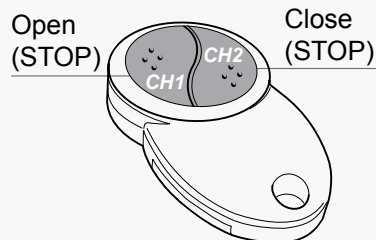
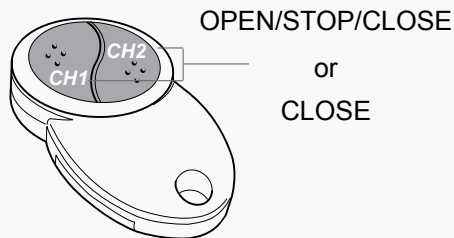

















3/18 channel transmitter



2 channel transmitter





















2.1 Radio codes memorization

TYPE OF MEMORIZATION		P1	  continuous sound keep it pressed	
A	1 BUTTON:    OPEN STOP CLOSE	* 1x	  	Press the button of the transmitter relative to the code to memorize.
B	AUTOMATIC COMMANDS (2 or 3 BUTTONS)	* 2x	   	Press the button of the transmitter relative to the code to memorize.
A	1 BUTTON:  CLOSE	* 3x	    	Press the button of the transmitter relative to the code to memorize.
C	7/42 CHANNEL TRANSMITTER	* 4x	     	Press any button of the 7/42 channel transmitter.

Press the button **P1** as many times as requested by the type of memorization and keep it pressed. The buzzer emits a continuous sound. Press the button of the transmitter relative to the code to memorize. The memorization is indicated by an intermittent sound of the buzzer.

2.2 Working time configuration

P1		   ... (>3 s) intermittent sound	
* 10x	         	  	Command a manoeuvre using a memorized transmitter or by means of the wired input.
Press the button P1 10 times and keep it pressed for 3 seconds. The buzzer emits an intermittent sound.		 	Press P1 again or wait 25 seconds to quit the procedure without saving.



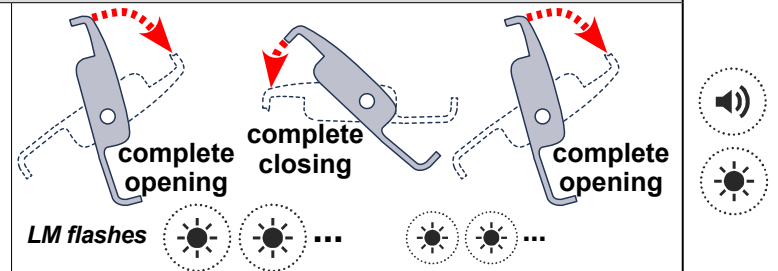





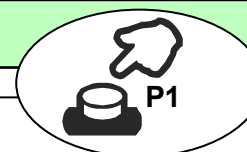















* The buzzer will make a beep each press.



Note: this automatic cycle can be stopped with any command. If working time is exceeded (90 s), the control unit stops and emits an intermittent sound until any button is pressed.

2.3 Radio codes deletion



TYPE OF DELETION	P1		    <i>keep it pressed</i>	
SINGLE RADIO CODE	* 5x	   	  	Press the button of the transmitter relative to the code to delete  <i>continuous sound</i>
Press 5 times the button P1 and keep it pressed. The buzzer emits an intermittent sound. Press the button of the transmitter relative to the code to be deleted within 10 seconds. Successful deletion is indicated by a continuous sound of the buzzer.				
ALL THE RADIO CODES	* 6x	    	       <i>intermittent sound</i> (10 s)	 <i>continuous sound</i>
Press 6 times the button P1 and keep it pressed for 10 seconds . The buzzer emits a fast intermittent sound. Release when the sound becomes continuous.				

* The buzzer will make a beep each press.

2.4 Remote memorization of further radio codes

2.5 Remote deletion of a radio code

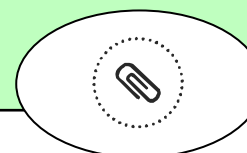

Note: P3 button is located inside the transmitter. The added radio code will have the same functions of the code used for the memorization. This procedure is compatible with any type of transmitter.

Note: P3 button is located inside the transmitter.

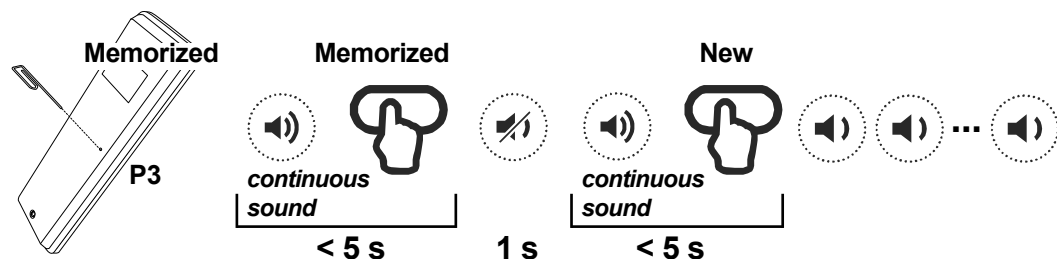

Press the button **P3** of the **memorized** transmitter. The buzzer emits a continuous sound. Press the button relative to a **memorized** code. The sound stops for 1 second then it starts again. Press the button relative to the **new** code. The memorization is indicated by an intermittent sound of the buzzer.

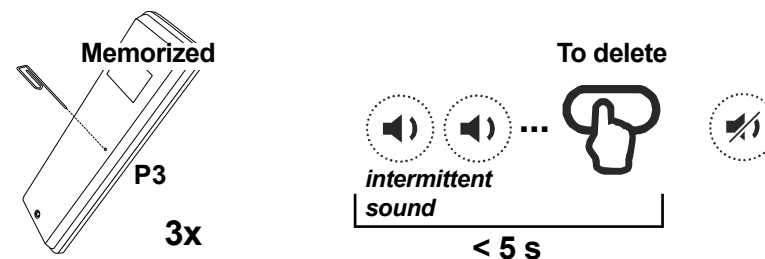

Press **3 times** the button **P3** of the **memorized** transmitter. The buzzer emits a slow intermittent sound. Press the button relative to the code **to delete** within 5 seconds. The buzzer will stop sounding.

3.1 WIND sensor

Alarm priority
HIGH

 L2 flashes

Factory setting
ACTIVATED

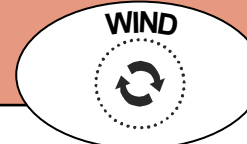

The anemometer (**ANEM4**) detects wind speed, which the control unit compares with the threshold set through **DIP4** (see table).
The control unit is only compatible with anemometers generating 4 pulses per rev.

ACTIVE ALARM when

The measured speed is higher than the set threshold (see the table).

Once ACTIVE ALARM

The control unit moves the louvres to the **50%** of complete opening and it **doesn't execute any command**. L2 flashes.

DEACTIVATED ALARM when

The sensor measures a speed lower than the set threshold for at least 30 seconds.

DIP4	Km/h
OFF	45
ON	60

3.2 RAIN sensor

 L1 ON

Factory setting
ACTIVATED

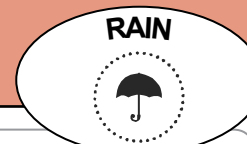

ALARM ACTIVATED when

The sensitive surface of the sensor detects drops of water.

What happens with ALARM ACTIVATED

The control unit completely **CLOSES** the pergola slats.
The control unit executes **no command**.

ALARM NOT ACTIVE when

The sensor doesn't detect any drop.

System operation AFTER rain alarm (draining of water)

DIP3=OFF: once the rain alarm has ended, for the following **6 hours** the control unit, upon receiving an automatic movement command from the transmitter, will tilt the pergola slats to **33%** to allow water to drain off. For **4 minutes** the control unit can only execute hold-to-run commands, thereby exiting from the alarm status.

DIP3=ON: once the rain alarm has ended, after 20 minutes the control unit will automatically tilt the pergola slats to **33%** to allow water to drain off. For **4 minutes** the control unit can only execute hold-to-run commands, thereby exiting from the alarm status.

Activation/ deactivation of the RAIN sensor

Deactivation

Press the "STOP" button of a memorized 7/42 or 3-channel transmitter for **10 s**.
The buzzer emits **2 beeps**.

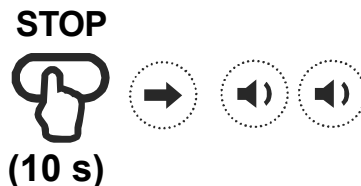

Activation

Press the "STOP" button of a memorized 7/42 or 3-channel transmitter for **10 s**.
The buzzer emits a continuous sound for **4 seconds**.

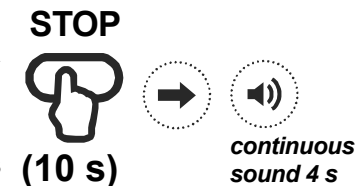

ATTENTION: the deactivation of the sensor has 60 minutes duration.

4 Technical specifications



Power supply	24V
Max. output power	4,5A
Working time	90 s
Operating temperature range	-20° / +50°C
Reception frequency	916 MHz
Radio memory capability (transmitters)	16
Rain sensor power supply	12V (max.100mA)
Anemometer	4 pulses/rotation (ANEM4)
Protection rating	IP54
Material of the box and its cover (Not suitable for direct UV exposure)	Thermoplastic ABS

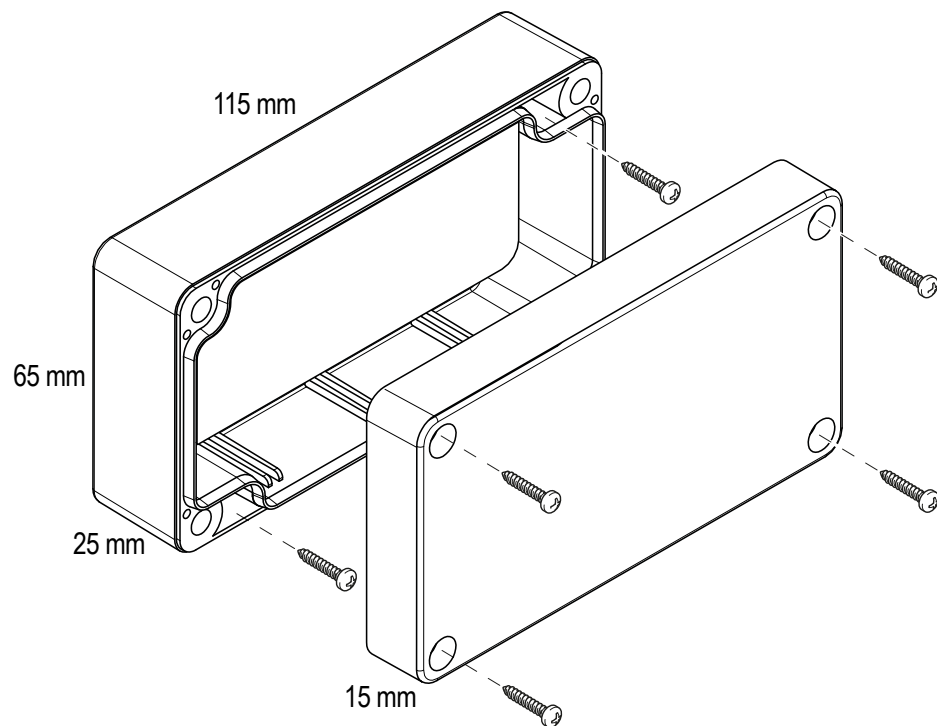
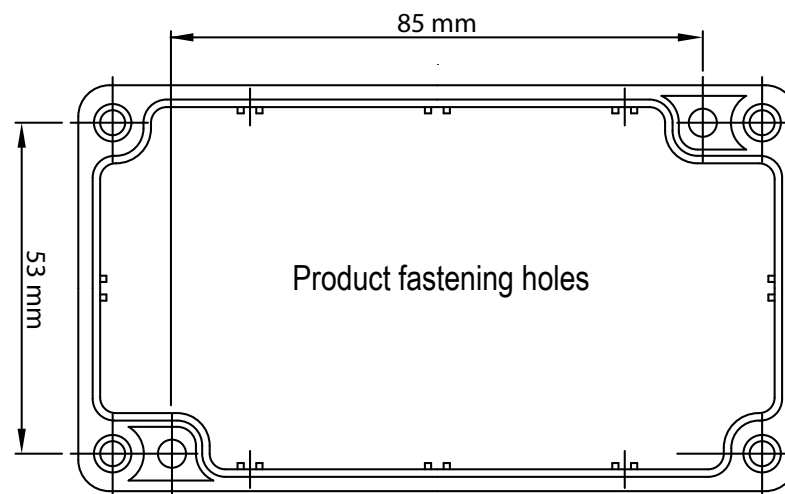

To prevent infiltration of water, wire the product as follows:

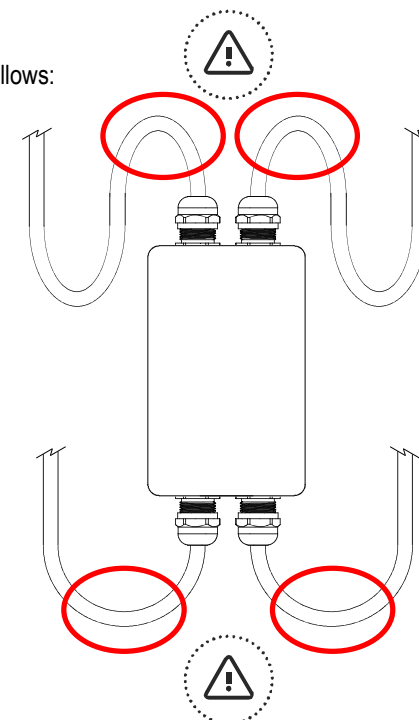

Teleco Automation S.r.l.
Italy
Tel. +39.0438.388511
Fax +39.0438.388536
info@telecoautomation.com

Teleco Automation France
France
Tel. +33.(0)472.145080
Fax +33.(0)472.140503
info@telecofrance.com

Teleco Automation GmbH
Germany
Tel. +49.(0)8122.9563024
Fax +49.(0)8122.9563026
info.de@telecoautomation.com

Teleco Automation Oceania Pty Ltd
Australia
Tel. +61.(07)5502.7801
info@telecoautomation.com.au



www.telecoautomation.com